

FM MODULATOR

KCA-R42FM

(K, M type)

SERVICE MANUAL

KENWOOD

© 2000-12 PRINTED IN JAPAN
B51-7708-00(S) 1744

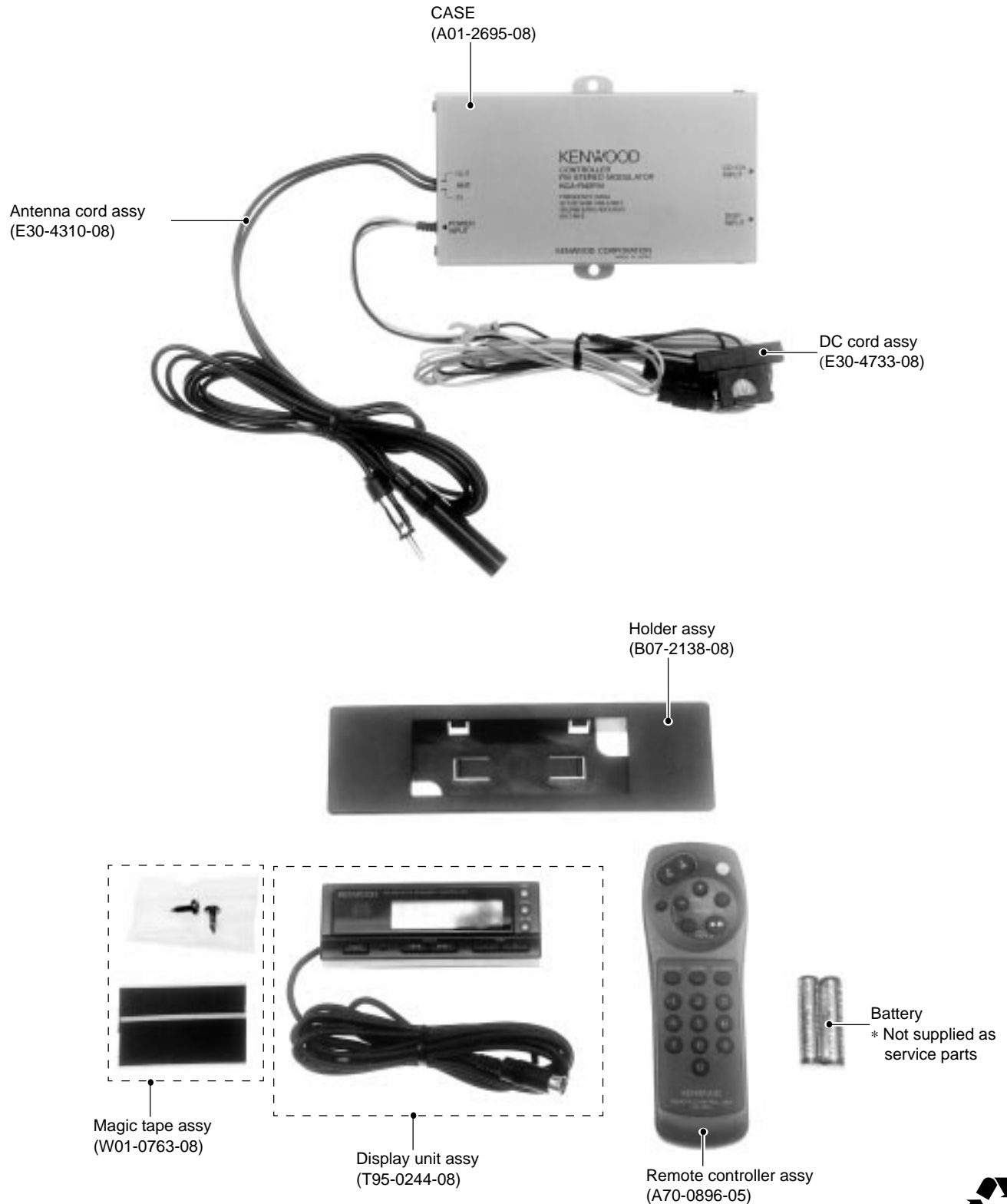

KCA-R42FM

BLOCK DIAGRAM

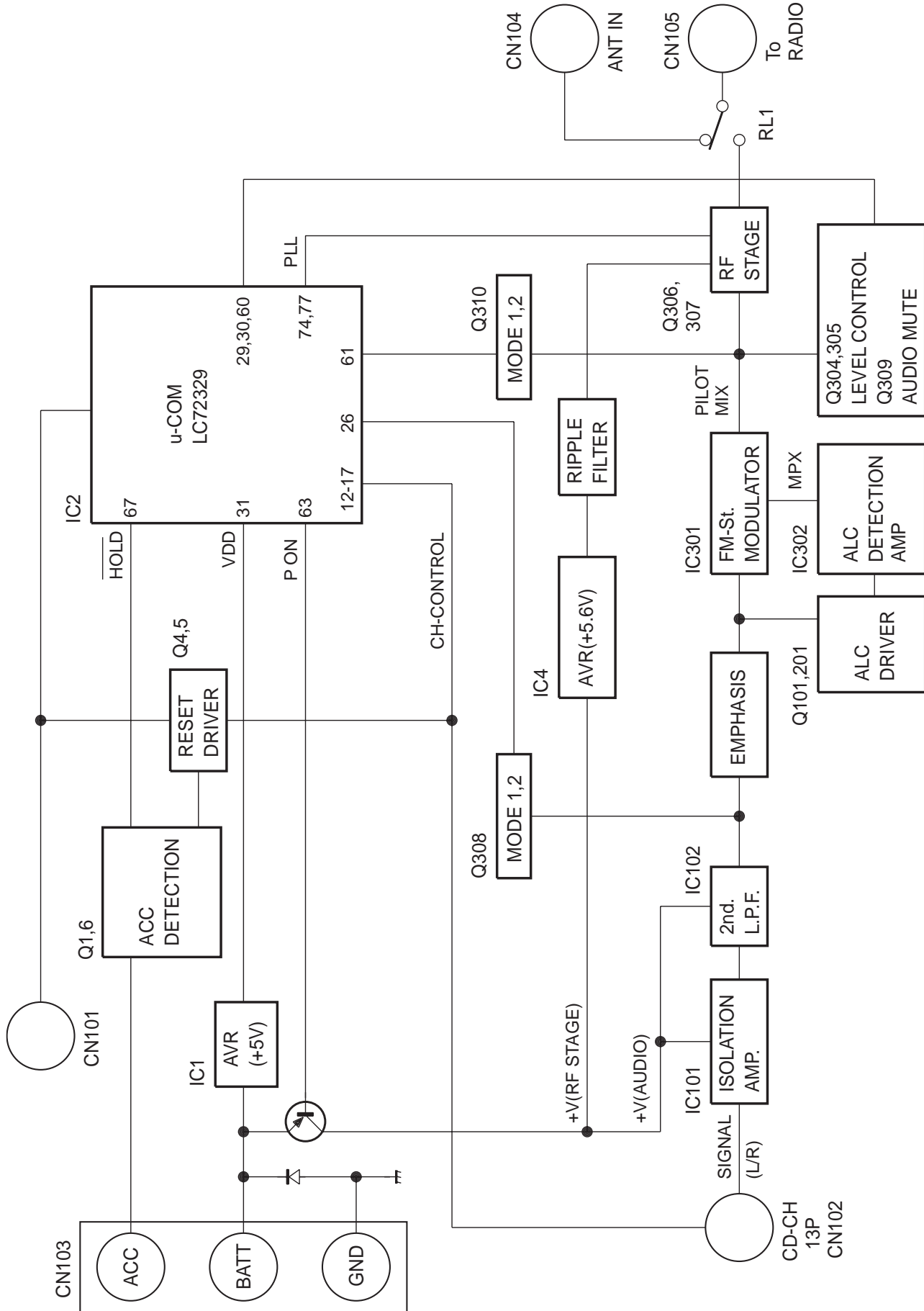

COMPONENT DESCRIPTION

●DISPLAY UNIT

Ref No.	Component Name	Appication / Function	Operation / Condition / Compatibility
IC1	LC75852W	LCD driver with key-matrix	
IC2	PNA4602M	Remote control light sensor	
Q1	DTC144EK	LED on / off sw	
Q2	DTB123YK		
Q3	DTA144EK	key-matrix permission sw	ready on key-matrix
Q4	DTC144EK	IC2 on / off sw	
Q5	DTA114EK		

●RF MODULATOR UNIT

Ref No.	Component Name	Appication / Function	Operation / Condition / Compatibility
IC1	UPC7805AHF	BU 5V AVR	
IC2	LC72329-9274	System MI-COM.	
IC4	NJM78L05UA	5V AVR	
IC101	NJM2060M	Isolation amp.	
IC102	NJM4565MD	Low pass filter	
IC301	BA1405F	FM ST modulator	
IC302	NJM4565MD	1/2 Vcc driver, ALC detection amp	
Q1	DTC124EK	ACC detection	
Q2	2SA1782(T,U)	Power sw	
Q3	DTC124EK		
Q4	DTC143TK	Reset sw	
Q5	DTC143TK	CH-Reset sw	
Q6	DTA124EK	Hold detection sw	
Q8	DTC143TK	Relay driver	
Q9	2SC4640(T,U)	Ripple filter	
Q101	2SK2158	ALC control sw	
Q201	2SK2158		
Q303	2SA1162(GR)	Pilot mix amp	
Q304	2SK2158	Level control sw	Level 1/2:L, Level 3/4:H
Q305			Level 2/4:L, Level 1/3:H
Q306	2SK508L	RF oscillator buffer	
Q307	2SC2714(Y)	RF amp.	
Q308	2SK2158	Mode (1/2) sw	Mode1:H, Mode2:L
Q309	2SK2158	Audio mute	Power on:L, Power off:H
Q310	2SK2158	Mode (1/2) sw	Mode1:L, Mode2:H

KCA-R42FM

ADJUSTMENT

• RF MODULATOR UNIT

1. DC balance adjustment (VR301)

While observing the waveform with a oscilloscope at pin 13 of IC301, adjust VR301 to minimize the waveform level.

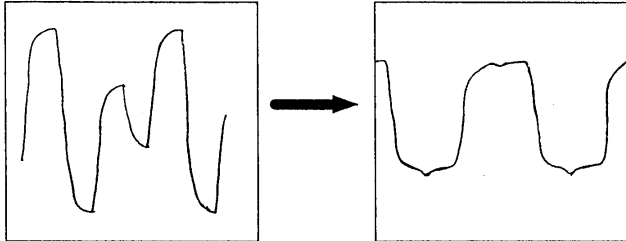

2. PLL control voltage adjustment (VC301)

First set the transmission frequency to *87.9 MHz with the commander, then adjust VC301 so that the DC Voltage at the + pole of C317, measured using a multimeter or digital tester, is + 3V (± 0.1 V).

3. Modulation level adjustment (VR303)

The method using a standard receiver or tuner.
Adjust VR303 so that the output level from the standard receiver or tuner is as specified.

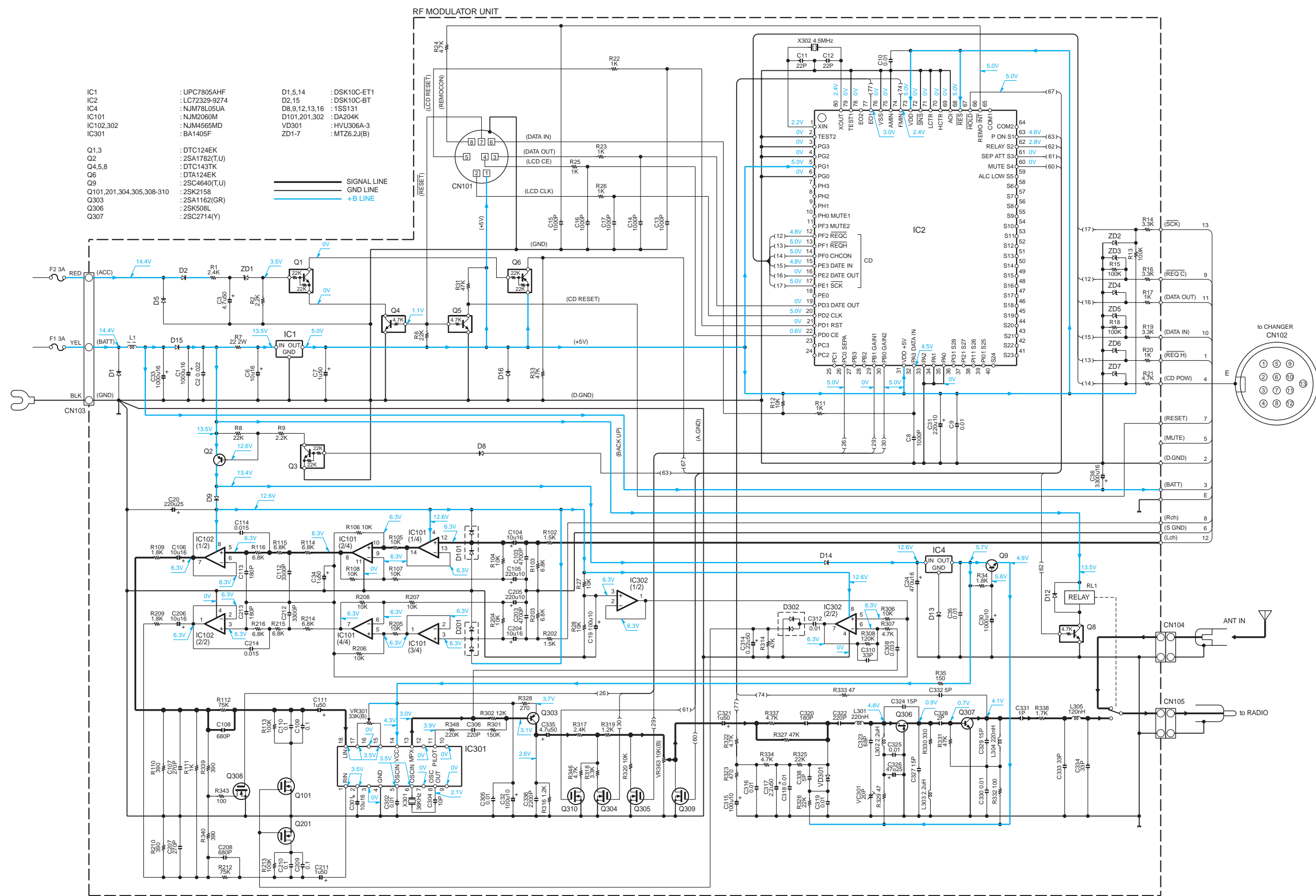

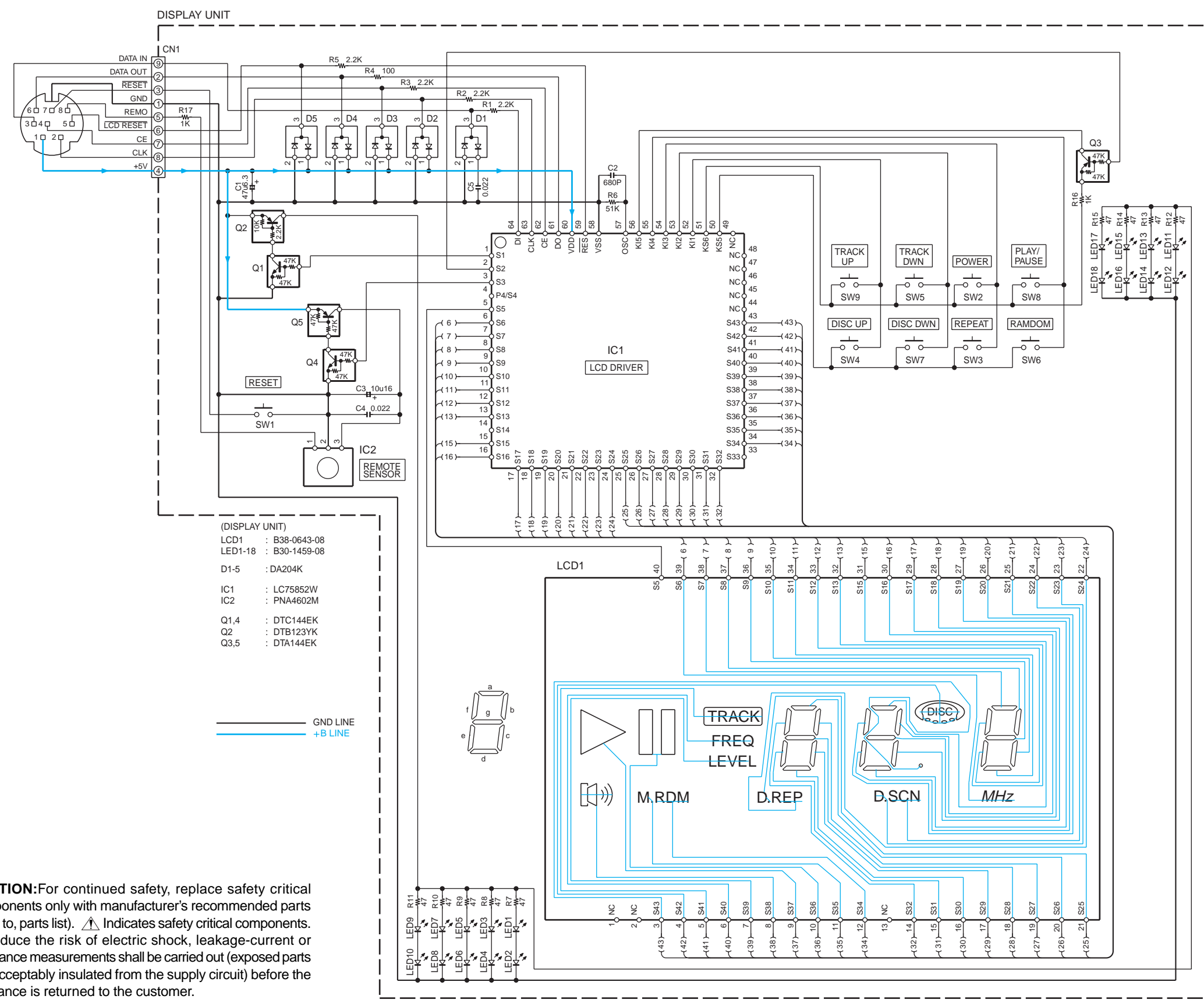

- (DISPLAY UNIT)
- LCD1 : B38-0643-08
 - LED1-18 : B30-1459-08
 - D1-5 : DA204K
 - IC1 : LC75852W
 - IC2 : PNA4602M
 - Q1,4 : DTC144EK
 - Q2 : DTB123YK
 - Q3,5 : DTA144EK

— GND LINE
 — +B LINE

CAUTION:For continued safety, replace safety critical components only with manufacturer's recommended parts (refer to, parts list). ⚠ Indicates safety critical components. To reduce the risk of electric shock, leakage-current or resistance measurements shall be carried out (exposed parts are acceptably insulated from the supply circuit) before the appliance is returned to the customer.

DC voltages are as measured with a high impedance voltmeter. Values may vary slightly due to variations between individual instruments or/and units.

2SC4640T/U

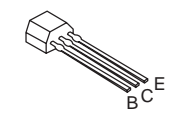

- DTA124EK
- DTA144EK
- DTB123YK
- DTC124EK
- DTC143TK
- DTC144EK
- 2SA1162
- 2SC2714

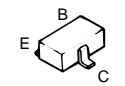

BA1405F

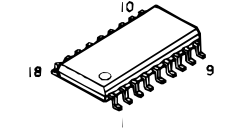

NJM78L05UA

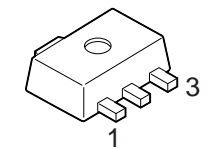

NJM4565MD

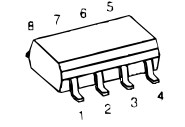

UPC7805AHF

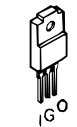

DA204K

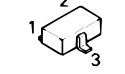

NJM2060M

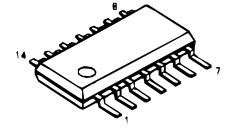

KCA-R42FM

EXPLODED VIEW (MECHANISM)

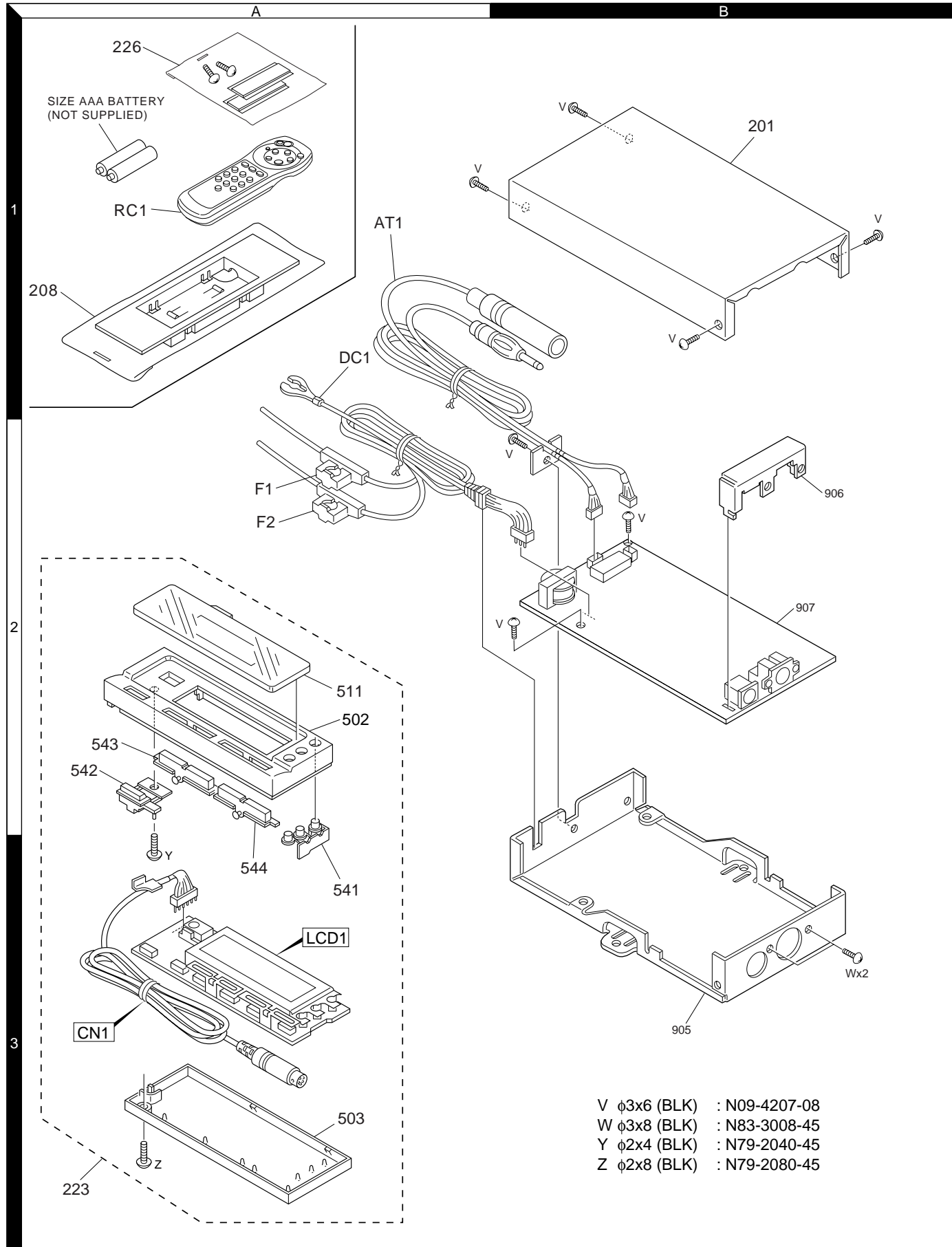

Parts with exploded numbers larger than 700 are not supplied.

KCA-R42FM

PARTS LIST

* New Parts

Parts without Parts No. are not supplied.

Les articles non mentionnés dans le Parts No. ne sont pas fournis.

Teile ohne Parts No. werden nicht geliefert.

Ref.No.	A d d	N e w	Parts No.	Description	Dest inati on
KCA-R42FM					
201	1B	*	A01-2775-08	CASE	
RC1	1A		A70-0896-05	REMOTE CONTROLLER ASSY	
208	1A		B07-2138-08	HOLDER ASSY	
-			B46-0100-50	WARRANTY CARD	
-			B58-1273-04	CAUTION CARD (P1,PRA,A6,1)	
-		*	B64-1930-00	INST.MANUAL(ENG.FRE.SPA.CHI.)	
AT1	1A		E30-4310-08	ANTENNA CORD ASSY	
DC1	1A		E30-4733-08	DC CORD	
F1,2	2A		F06-3026-05	FUSE (3A)	
-			H12-2661-08	INNER CARTON CASE (RF MODU.)	
-			H13-1766-08	CARTON BOARD	
-			H19-0604-08	PROTECTION BOARD (RF MODU.)	
-			H25-0233-04	PROTECTION BAG (80X120X0.05)	
-			H25-0236-04	PROTECTION BAG (100X400X0.05)	
-			H25-0337-04	PROTECTION BAG (180X300X0.03)	
-			H25-1101-04	PROTECTION BAG (180X500X0.03)	
-		*	H54-2078-08	ITEM CARTON CASE	
V	1B		N09-4207-08	SCREW (3X6,Ni-B)	
W	3B		N83-3008-45	SCREW (3X8) 001900	
Y	3A		N79-2040-45	SCREW (POWER-KEY x1)	
Z	3A		N79-2080-45	SCREW (REAR CASE x1)	
223	3A		T95-0244-08	DISPLAY UNIT ASSY	
226	1A		W01-0763-08	MAGIC TAPE ASSY	
RF MODULATOR UNIT					
C1			C90-2583-05	ELECTRO 1000UF 16WV	
C2			CK73FB1H223K	CHIP C 0.022UF K	
C3			CE04NW1H4R7M	ELECTRO 4.7UF 50WV	
C6			CE04NW1C100M	ELECTRO 10UF 16WV	
C7			CE04NW1H010M	ELECTRO 1UF 50WV	
C8			CK73FB1H102K	CHIP C 1000PF K	
C9,10			CK73FB1H103K	CHIP C 0.010UF K	
C11,12			CC73FCH1H220J	CHIP C 22PF J	
C13-17			CK73FB1H102K	CHIP C 1000PF K	
C19			CE04DW1A101M	ELECTRO 100UF 10WV	
C20			CE04DW1E221M	ELECTRO 220UF 25WV	
C24			CE04DW1C471M	ELECTRO 470UF 16WV	
C30			CE04DW1A102M	ELECTRO 1000UF 10WV	
C31			CE04DW1A221M	ELECTRO 220UF 10WV	
C32			CE04DW1A101M	ELECTRO 100UF 10WV	
C33			C90-2583-05	ELECTRO 1000UF 16WV	
C34			CE04NW1H010M	ELECTRO 1UF 50WV	
C35			CK73FB1H103K	CHIP C 0.01UF K	
C36			C90-2689-05	ELECTRO 3300UF 16WV	
C103			CK73FB1H103K	CHIP C 0.01UF K	
C104			CE04NW1C100M	ELECTRO 10UF 16WV	
C105			CE04DW1A221M	ELECTRO 220UF 10WV	
C106			CE04NW1C100M	ELECTRO 10UF 16WV	
C107			CC73FCH1H271J	CHIP C 270PF J	
C108			CK73FB1H102K	CHIP C 1000PF K	

E: Europe K: North America M: Other Areas

W: Without Europe

KCA-R42FM RF MODULATOR UNIT

Ref.No.	A d d	N e w	Parts No.	Description	Dest inati on
C109,110			CK73FF1H104Z	CHIP C 0.10UF Z	
C111			CE04NW1H010M	ELECTRO 1UF 50WV	
C112			CK73FB1H332K	CHIP C 3300PF K	
C113			CC73FCH1H181J	CHIP C 180PF J	
C114			CK73FB1H153KTA	CHIP C 0.015UF K	
C115			CK73FB1H682K	CHIP C 6800PF K	
C203			CK73FB1H103K	CHIP C 0.01UF K	
C204			CE04NW1C100M	ELECTRO 10UF 16WV	
C205			CE04DW1A221M	ELECTRO 220UF 10WV	
C206			CE04NW1C100M	ELECTRO 10UF 16WV	
C207			CC73FCH1H271J	CHIP C 270PF J	
C208			CK73FB1H102K	CHIP C 1000PF K	
C209,210			CK73FF1H104Z	CHIP C 0.10UF Z	
C211			CE04NW1H010M	ELECTRO 1UF 50WV	
C212			CK73FB1H332K	CHIP C 3300PF K	
C213			CC73FCH1H181J	CHIP C 180PF J	
C214			CK73FB1H153KTA	CHIP C 0.015UF K	
C215			CK73FB1H682K	ELECTRO 6800PF 50WV	
C301			CE04NW1C100M	ELECTRO 10UF 16WV	
C302			CK73FB1H103K	CHIP C 0.010UF K	
C304			CC73FCH1H100D	CHIP C 10PF D	
C305			CK73FB1H103K	CHIP C 0.010UF K	
C306			CC73FCH1H221J	CHIP C 220PF J	
C308			CK73FB1H333K	CHIP C 0.033UF K	
C310			CC73FCH1H330J	CHIP C 33PF J	
C312			CK73FB1H103K	CHIP C 0.010UF K	
C314			CE04NW1HR22M	ELECTRO 0.22UF 50WV	
C315			CE04DW1A101M	ELECTRO 100UF 10WV	
C316			CK73FB1H103K	CHIP C 0.010UF K	
C317			CE04NW1H2R2M	ELECTRO 2.2UF 50WV	
C318,319			CK73FB1H103K	CHIP C 0.010UF K	
C320			CC73FCH1H181J	CHIP C 180PF J	
C321			CE04NW1H010M	ELECTRO 1UF 50WV	
C322			CC73FUJ1H221J	CHIP C 220PF J	
C323			CC73FUJ1H680J	CHIP C 68PF J	
C324			CC73FUJ1H150J	CHIP C 15PF J	
C325			CK73FB1H103K	CHIP C 0.010UF K	
C326			CE04DW1E470M	ELECTRO 47UF 25WV	
C327			CC73FUJ1H150J	CHIP C 15PF J	
C328			CC73FCH1H020C	CHIP C 2.0PF C	
C329			CC73FCH1H150J	CHIP C 15PF J	
C330			CK73FB1H103K	CHIP C 0.010UF K	
C331			CC73FCH1H010C	CHIP C 1.0PF C	
C332			CC73FCH1H050C	CHIP C 5.0PF C	
C333,334			CC73FCH1H330J	CHIP C 33PF J	
C335			CE04NW1H4R7M	ELECTRO 4.7UF 50WV	
C336			CK73FB1H222K	CHIP C 2200PF K	
C338			CC73FCH1H050C	CHIP C 5PF C	
VC301			C05-0513-08	TRIMMER 20P	
CN101	2B		E56-0811-05	CONNECTOR (8P)	
CN102	2B	*	E56-0833-08	CONNECTOR (13P)	
CN104,105			E40-3237-05	PIN ASSY	
L1			L33-0934-08	CHOKING COIL	
L301			L33-1043-08	SMALL FIXED INDUCTOR (0.22uH)	

⚠ indicates safety critical components.

PARTS LIST

* New Parts

Parts without Parts No. are not supplied.

Les articles non mentionnes dans le Parts No. ne sont pas fournis.

Teile ohne Parts No. werden nicht geliefert.

RF MODULATOR UNIT

Ref.No.	A d d	N e w	Parts No.	Description	Dest inati on
L302,303			L33-0976-08	SMALL FIXED INDUCTOR (2.2uH)	
L304			L33-1043-08	SMALL FIXED INDUCTOR (0.22uH)	
L305			L33-1042-08	SMALL FIXED INDUCTOR (0.12uH)	
X301			L77-2716-08	CRYSTAL RESONATOR (38KHz)	
X302			L77-2062-08	CRYSTAL RESONATOR (4.5MHz)	
V	1B		N09-4207-08	SCREW (3X6,Ni-B)	
W	3B		N09-4206-08	SCREW (for CN102 x2)(3X8)	
R1			RD14BB2C242J	RD 2.4K J 1/6W	
R2			RD14BB2C222J	RD 2.2K J 1/6W	
R6			RK73FB2A223J	CHIP R 22K J 1/10W	
R7			R92-2148-08	CHIP R 22 J 2W	
R8			RD14BB2C223J	RD 22K J 1/6W	
R9			RD14BB2C222J	RD 2.2K J 1/6W	
R11			RD14BB2C102J	RD 1.0K J 1/6W	
R12			RD14BB2C103J	RD 10K J 1/6W	
R13			RD14BB2C104J	RD 100K J 1/6W	
R14			RD14BB2C332J	RD 3.3K J 1/6W	
R15			RD14BB2C104J	RD 100K J 1/6W	
R16			RD14BB2C332J	RD 3.3K J 1/6W	
R17			RD14BB2C102J	RD 1K J 1/6W	
R18			RK73FB2A104J	CHIP R 100K J 1/10W	
R19			RD14BB2C332J	RD 3.3K J 1/6W	
R20			RD14BB2C102J	RD 1K J 1/6W	
R21			RD14BB2C472J	RD 4.7K J 1/6W	
R22,23			RD14BB2C102J	RD 1.0K J 1/6W	
R24			RD14BB2C472J	RD 4.7K J 1/6W	
R25,26			RD14BB2C102J	RD 1.0K J 1/6W	
R27,28			RK73FB2A103J	CHIP R 10K J 1/10W	
R31			RK73FB2A473J	CHIP R 47K J 1/10W	
R33			RK73FB2A473J	CHIP R 47K J 1/10W	
R34			RK73FB2A182J	CHIP R 1.8K J 1/10W	
R35			RK73FB2A151J	CHIP R 150 J 1/10W	
R102			RK73FB2A152J	CHIP R 1.5K J 1/10W	
R103			RK73FB2A682J	CHIP R 6.8K J 1/10W	
R104			RK73FB2A103J	CHIP R 10K J 1/10W	
R105-108			R92-0363-05	CHIP R 10K F 1/10W	
R109			RK73FB2A182J	CHIP R 1.8K J 1/10W	
R110			RK73FB2A391J	CHIP R 390 J 1/10W	
R111			RK73FB2A102J	CHIP R 1.0K J 1/10W	
R112			RK73FB2A753J	CHIP R 75K J 1/10W	
R114-116			RK73FB2A682J	CHIP R 6.8K J 1/10W	
R202			RK73FB2A152J	CHIP R 1.5K J 1/10W	
R203			RK73FB2A682J	CHIP R 6.8K J 1/10W	
R204			RK73FB2A103J	CHIP R 10K J 1/10W	
R205-208			R92-0363-05	CHIP R 10K D 1/10W	
R209			RK73FB2A182J	CHIP R 1.0K J 1/10W	
R210			RK73FB2A391J	CHIP R 390 J 1/10W	
R212			RK73FB2A753J	CHIP R 75K J 1/10W	
R214-216			RK73FB2A682J	CHIP R 6.8K J 1/10W	
R301			RK73FB2A154J	CHIP R 150K J 1/10W	
R302			RK73FB2A123J	CHIP R 12K J 1/10W	
R306			RK73FB2A103J	CHIP R 10K J 1/10W	
R307			RK73FB2A472J	CHIP R 4.7K J 1/10W	
R308			RK73FB2A154J	CHIP R 150K J 1/10W	

Ref.No.	A d d	N e w	Parts No.	Description	Dest inati on
R314			RK73FB2A473J	CHIP R 47K J 1/10W	
R316			RK73FB2A122J	CHIP R 1.2K J 1/10W	
R317			RK73FB2A242J	CHIP R 2.4K J 1/10W	
R318			RK73FB2A332J	CHIP R 2.7K J 1/10W	
R319			RD14BB2C122J	RD 1.2K J 1/6W	
R320			RK73FB2A103J	CHIP R 10K J 1/10W	
R322			RD14BB2C472J	RD 4.7K J 1/6W	
R323			RK73FB2A471J	CHIP R 470 J 1/10W	
R325,326			RK73FB2A223J	CHIP R 22K J 1/10W	
R327			RK73FB2A473J	CHIP R 47K J 1/10W	
R328			RK73FB2A271J	CHIP R 270 J 1/10W	
R329			RK73FB2A470J	CHIP R 47 J 1/10W	
R330			RK73FB2A331J	CHIP R 330 J 1/10W	
R331			RK73FB2A473J	CHIP R 47K J 1/10W	
R332			RK73FB2A101J	CHIP R 100 J 1/10W	
R333			RK73FB2A470J	CHIP R 47 J 1/10W	
R334			RK73FB2A472J	CHIP R 4.7K J 1/10W	
R335			RK73FB2A8R2J	CHIP R 8.2 J 1/10W	
R337,338			RK73FB2A472J	CHIP R 4.7K J 1/10W	
R339,340			RK73FB2A391J	CHIP R 390 J 1/10W	
R343			RK73FB2A101J	CHIP R 100 J 1/10W	
R346			RK73FB2A472J	CHIP R 4.7K J 1/10W	
R348			RK73FB2A224J	CHIP R 220K J 1/10W	
VR301			R32-0208-08	TRIMING POT. 33K(B)	
VR303			R32-0207-08	TRIMING POT. 10K(B)	
RL1			S76-0802-08	MAGNET RELAY	
D1			DSK10C-ET1	DIODE	
D2			DSK10C-BT	DIODE	
D5			DSK10C-ET1	DIODE	
D8-9			1SS131	DIODE	
D12,13			1SS131	DIODE	
D14			DSK10C-ET1	DIODE	
D15			DSK10C-BT	DIODE	
D16			1SS131	DIODE	
D101			DA204K	DIODE	
D201			DA204K	DIODE	
D302			DA204K	DIODE	
IC1			UPC7805AHF	IC(VOLTAGE REGULATOR/ +5V))	
IC2			LC72329-9274	IC (MICRO COMPUTER)	
IC4			NJM78L05UA	IC(VOLTAGE REGULATOR/ +5V))	
IC101			NJM2060M	IC(OP AMP X4))	
IC102			NJM4565MD	IC(OP AMP X2))	
IC301			BA1405F	IC (MPX)	
IC302			NJM4565MD	IC(OP AMP X2))	
Q1			DTC124EK	DIGITAL TRANSISTOR	
Q2			2SA1782(T,U)	TRANSISTOR	
Q3			DTC124EK	DIGITAL TRANSISTOR	
Q4,5			DTC143TK	DIGITAL TRANSISTOR	
Q6			DTA124EK	DIGITAL TRANSISTOR	
Q8			DTC143TK	DIGITAL TRANSISTOR	
Q9			2SC4640T/U	TRANSISTOR	
Q101			2SK2158	FET	
Q201			2SK2158	FET	
Q303			2SA1162(GR)	TRANSISTOR	

E: Europe K: North America M: Other Areas
W: Without Europe

⚠ indicates safety critical components.

KCA-R42FM

PARTS LIST

* New Parts

Parts without Parts No. are not supplied.

Les articles non mentionnes dans le Parts No. ne sont pas fournis.

Teile ohne Parts No. werden nicht geliefert.

RF MODULATOR UNIT DISPLAY UNIT ASSY(T95-0244-08)

Ref.No.	A d d	N e w	Parts No.	Description	Dest inati on
Q304,305 Q306 Q307 Q308-310 VD301 ZD1-7			2SK2158 2SK508L 2SC2714(Y) 2SK2158 HVU306A-3 MTZ6.2J(B)	FET FET TRANSISTOR FET VARIABLE DIODE ZENER DIODE	
DISPLAY UNIT ASSY (T95-0244-08)					
502 503	2A 3A		A02-1460-08 A02-1446-08	FRONT CASE REAR CASE	
511 LCD1 LED1-18	2A 3A		B10-3057-08 B38-0643-08 B30-1459-08	FRONT GLASS ASSY LCD LED	
C1 C2 C3 C4,5			C92-0047-05 CK73GB1H681K C92-0037-05 CK73FB1H223KTA	CHIP-ELE 47UF 6.3WV CHIP C 680PF K CHIP-ELE 10UF 16WV CHIP C 0.022UF K	
CN1	3A		E30-4309-08	DIN CORD ASSY (8P)	
541 542 543 544	3A 2A 2A 3A		K25-0713-08 K29-5576-08 K29-5585-08 K29-5586-08	KNOB (REP, RDM, PLAY/PAUSE) KNOB ASSY (PWR, RESET) KNOB (TRACK) KNOB (DISC)	
Y Z	3A 3A		N79-2040-45 N79-2080-45	SCREW (POWER-KEY x1) SCREW (REAR CASE x1)	
R1-3 R4 R5 R6 R7-15			RK73GB1J222J RK73GB1J101J RK73GB1J222J RK73GB1J513J RK73FB2A470J	CHIP R 2.2K J 1/16W CHIP R 100 J 1/16W CHIP R 2.2K J 1/16W CHIP R 51K J 1/16W CHIP R 47 J 1/10W	
R16,17			RK73GB1J102J	CHIP R 1.0K J 1/16W	
SW1-9			S70-0828-08	TACT SWITCH	
D1-5 IC1 IC2 Q1 Q2			DA204K LC75852W PNA4602M DTC144EK DTB123YK	DIODE IC (LCD DRIVER) IC (REMOTE SENSOR) DIGITAL TRANSISTOR DIGITAL TRANSISTOR	
Q3 Q4 Q5			DTA144EK DTC144EK DTA144EK	DIGITAL TRANSISTOR DIGITAL TRANSISTOR DIGITAL TRANSISTOR	

Ref.No.	A d d	N e w	Parts No.	Description	Dest inati on

E: Europe K: North America M: Other Areas
W: Without Europe

⚠ indicates safety critical components.

KCA-R42FM

SPECIFICATIONS

Specifications subject to change without notice.

Modulating Frequency (200 kHz STEP)..... 87.7, 87.9, 88.1, 88.3, 88.5,
88.7, 88.9, 89.1, 89.3,
89.5, 89.7, 89.9 MHz

General

Operating Voltage 14.4 V (11 ~ 16 V)
Current Consumption 1.4 A
Operating Temperature -10 ~ 50°C

Size (W X H X D)

Controller 50 × 145 × 24 mm
(1-15/16 × 5-11/16 × 15/16 in.)
Display unit 105 × 40 × 18 mm
(4-1/8 × 1-9/16 × 11/16 in.)
FM modulator unit 150 × 30 × 80 mm
(5-7/8 × 1-3/16 × 3-1/8 in.)
Trim mount plate 188 × 58 × 2 mm
(7-3/8 × 2-5/16 × 1/16 in.)

Weight

Controller 60g (0.14 lbs)
Display Unit 125 g (0.28 lbs)
FM modulator unit 600 g (1.3 lbs)

KENWOOD follows a policy of continuous advancements in development. For this reason specifications may be changed without notice.

KENWOOD CORPORATION

14-6, Dogenzaka 1-chome, Shibuya-ku, Tokyo 150-8501, Japan

KENWOOD SERVICE CORPORATION

P.O. Box 22745, 2201 East Dominguez Street,
Long Beach, CA90801-5745, U.S.A.

KENWOOD ELECTRONICS CANADA INC.

6070 Kestrel Road, Mississauga, Ontario, Canada L5T 1S8

KENWOOD ELECTRONICS LATIN AMERICA S.A.

P.O. Box 55-2791, Piso 6, Plaza Chase, Cl. 47 y,
Aquilino de la Guardia, Panama, Republic of Panama

KENWOOD ELECTRONICS BRASIL LTDA.

Av. Moema, 170-17°, Andar-Cobertura "B",
Ed. Maximum Service Center, 04077-020 Moema,
São Paulo-SP-Brasil

KENWOOD ELECTRONICS UK LIMITED

Kenwood House, Dwight Road, Watford, Herts,
WD1 8EB United Kingdom

KENWOOD ELECTRONICS DEUTSCHLAND GMBH

Rembrücker-Str. 15, 63150 Heusenstamm, Germany

KENWOOD ELECTRONICS FRANCE S.A.

13, Boulevard Ney, 75018 Paris, France

KENWOOD ELECTRONICS BELGIUM N.V.

Mechelsesteenweg 418, B-1930 Zaventem, Belgium

KENWOOD ELECTRONICS ITALIA S.p.A.

Via G. Sirtori 7/9, 20129 Milano, Italy

KENWOOD IBÉRICA S.A.

Bolivia, 239-08020 Barcelona, Spain

KENWOOD ELECTRONICS AUSTRALIA PTY. LTD.

(A.C.N. 001 499 074)
16 Giffnock Avenue, North Ryde, N.S.W. 2113, Australia

KENWOOD ELECTRONICS (HONG KONG) LTD.

Unit 3712-3724, Level 37, Tower 1, Metroplaza,
223 Hing Fong Road, Kwai Fong, N.T., Hong Kong

KENWOOD ELECTRONICS GULF FZE

P.O. Box 61318, Jebel Ali, Dubai, U.A.E.

KENWOOD ELECTRONICS (THAILAND) CO., LTD.

2019 New Pechburi Road, Bangkapi, Huaykwang,
Bangkok, 10320 Thailand

KENWOOD ELECTRONICS SINGAPORE PTE. LTD.

1 Genting Lane, #07-00, Kenwood Building, Singapore 349544

KENWOOD ELECTRONICS (MALAYSIA) SDN BHD

#4.01 Level 4, Wisma Academy Lot 4A, Jalan 19/1,
46300 Petaling Jaya, Selangor Darul Ehsan, Malaysia